

# HELPMAN

## Air cooled Condensers

# HTC

*New condenser generation with better performance*

Capacities 9 - 1060 kW



**Ripple Fin® tubing**

**Floating coil block suspension**

**Eurovent certified**

**Capacities based on  
ENV 327 voor R404A**

EUROVENT  
CERTIFIED PERFORMANCE



CERTIFY-ALL

\*DX Air Coolers  
Air Cooled Condensers  
Dry Coolers

# Air Cooled Condensers

# HTC

## Contents

Page	
3	General information
4 - 11	Nominal duty air flow, sound levels technical data, dimensions
12	Fan types Fan motors
13	Capacity calculation Correction factors
14	Extended feet Additional information

## Certified by Eurovent

HTC aircooled condensers are tested and certified by Eurovent according to ENV 327 European standard.

This extensive testing procedure comprises :

- capacities under standardised conditions
- air flow data
- sound levels
- fan capacities

## Type indication

Example :     **HTC 076 . 124 - 930**

- HTC** : Aircooled condenser with Cu/Al coil block
- 076** : Condenser type  
There are 5 basic types with different fan diameters
- 1••** : Number of separated coils
- 2•** : Number of fans per coil
- 4** : Number of tube rows in air direction
- 930** : Fan speed

## Air Cooled Condensers

**HTC**



### General

The HTC aircooled condenser range includes 5 basic types covering a total of 137 models with 1 to 12 fans and duties from 9 to 1060 kW at 15 K temperature difference.

### Design

Coil block	: Copper Ripple Fin® tubing with aluminium fins.
Tube diameter	: 1/2"
Tube pitch	: 50 x 50 mm triangle
Fin spacing	: 2.25 mm

Other fin spacings up to 4 mm available on request.

Coil blocks are pressure tested at 28 bar dry air.

Casing and framework are of pregalvanised sheet steel (Sendzimir) with an epoxy coating on both sides. Colour scheme: light-grey RAL 7035, mounting feet models 076, 090, 091 and 100, dark-grey RAL 7016. Other colours are available at an extra price. All condensers are provided with removable header panels.

Floating construction of the condenser coil block. On request the condensers can be fitted with inspection hatches (extra price).

### Air direction

Condensers type HTC can be supplied for horizontal or vertical air flow.

#### Condenser models 050 :

Standard horizontal air flow, vertical air flow with special refrigerant circuiting. All models are fitted with mounting profiles.

#### Condenser models 076, 090, 091 and 100 :

Standard vertical air flow. On request also available for horizontal air flow.

When ordering without air flow indication, the standard execution will be supplied.

### Corrosion protection

The standard condensers have a high corrosion resistance through selected materials, surface treatment and construction. For application in aggressive surroundings (coastal-and industrial areas) following designs are available at an extra charge:

- fins of seawater resistant aluminium alloy (57S/5052)
- fins of prepainted aluminium
- finned coil coated after assembling

### Application as liquid cooler (Dry - Cooler)

The condenser can also be used as liquid cooler, for instance cooling down of cooling water in watercooled plants.

Technical information on request, see brochure nr. 53.08 (Dry Coolers HTD).

# Air Cooled Condensers

# HTC

## Capacities HTC ... . 2..

Type	Capacity kW	Airflow m <sup>3</sup> /h	dB(A)	Capacity kW	Airflow m <sup>3</sup> /h	dB(A)	Cap.	AirflowdB(A)	Cap.	AirflowdB(A)				
HTC	H	H	H	H L	H L	H/L	kW	m <sup>3</sup> /h	kW	m <sup>3</sup> /h				
<b>HTC 050</b>														
<hr/>														
<hr/>														
<b>HTC 076</b>	<b>n = 930 rpm</b>			<b>n = 935 / 425 rpm</b>			<b>n = 690 rpm</b>			<b>n = 325 rpm</b>				
076 . 212 - ...	73.6	29300	56	73.6	45.7	29300	14600	56/42	60.6	20700	49	40.4	12000	36
076 . 213 - ...	95.2	27700	56	95.2	56.6	27700	14200	56/42	76.2	19600	49	45.8	10600	36
076 . 214 - ...	104.3	26200	56	104.3	63.9	26200	13900	56/42	85.8	18600	49	46.2	9300	36
076 . 222 - ...	148.1	58600	59	148.1	96.9	58600	29100	59/45	121.8	41500	52	80.8	24000	39
076 . 223 - ...	191.6	55400	59	191.6	117.8	55400	28400	59/45	152.8	39200	52	91.6	21200	39
076 . 224 - ...	221.2	52500	59	221.2	128.3	52500	27800	59/45	172.7	37200	52	92.4	18600	39
076 . 232 - ...	229.9	87900	61	229.9	141.4	87900	43700	61/47	188.6	62200	54	121.2	36000	41
076 . 233 - ...	288.3	83200	61	288.3	176.2	83200	42700	61/47	238.9	58700	54	137.4	31800	41
076 . 234 - ...	322.2	78700	61	322.2	194.1	78700	41700	61/47	252.4	55700	54	138.6	27900	41
076 . 242 - ...	282.5	117200	62	282.5	195.1	117200	58300	62/48	259.9	82900	55	161.6	48000	42
076 . 243 - ...	397.8	110900	62	397.8	232.9	110900	56900	62/48	316.0	78300	55	183.2	42400	42
076 . 244 - ...	444.4	104900	62	444.4	254.0	104900	55600	62/48	345.9	74300	55	184.8	37200	42
076 . 252 - ...	371.8	146500	63	371.8	247.4	146500	72800	63/49	304.8	103700	56	202.0	60000	43
076 . 253 - ...	476.0	138600	63	476.0	296.7	138600	71100	63/49	402.0	97900	56	229.0	53000	43
076 . 254 - ...	563.5	131200	63	563.5	323.0	131200	69500	63/49	439.4	92900	56	231.0	46500	43
076 . 262 - ...	461.6	175800	64	461.6	283.3	175800	87400	64/50	377.6	124400	57	242.4	72000	44
076 . 263 - ...	602.6	166300	64	602.6	358.3	166300	85300	64/50	460.0	117500	57	274.8	63600	44
076 . 264 - ...	645.8	157400	64	645.8	388.5	157400	83500	64/50	505.5	111500	57	277.2	55800	44

H = High fan speed

L = Low fan speed

# Air Cooled Condensers

# HTC

## Technical Data HTC ... . 2••

Type	Refrigerant conn. mm	Int. vol. dm <sup>3</sup>	Sur-face m <sup>2</sup>	Weight kg	Dimensions mm			
					A	B	C	D
<b>HTC 050</b>								
<b>HTC 076 n = 930 rpm</b>								
076.212-...	2 x 28	17	204	255				
076.213-...	2 x 28	26	306	293	2000	1340		1x1400
076.214-...	2 x 28	35	408	330				
076.222-...	2 x 35	31	408	506				
076.223-...	2 x 42	47	612	579	3400	2740		2x1400
076.224-...	2 x 42	63	817	652				
076.232-...	2 x 42	49	612	762				
076.233-...	2 x 54	74	919	873	4800	4140		3x1400
076.234-...	2 x 54	99	1225	984				
076.242-...	2 x 54	63	817	1013				
076.243-...	2 x 54	95	1225	1159	6200	5540	2740	4x1400
076.244-...	2 x 67	127	1633	1305				
076.252-...	2 x 54	77	1021	1264				
076.253-...	2 x 67	116	1531	1445	7600	6940	4140	5x1400
076.254-...	2 x 67	155	2042	1627				
076.262-...	2 x 67	91	1225	1514				
076.263-...	2 x 67	137	1837	1732	9000	8340	4140	6x1400
076.264-...	2 x 67	183	2450	1949				
<b>HTC 090 n = 850 / 610 rpm</b>								
090.212-...	2 x 28	21	245	460				
090.213-...	2 x 35	31	367	505	2000	1340		1x1400
090.214-...	2 x 35	42	490	551				
090.222-...	2 x 42	38	490	915				
090.223-...	2 x 54	57	735	1003	3400	2740		2x1400
090.224-...	2 x 54	76	980	1091				
090.232-...	2 x 54	59	735	1376				
090.233-...	2 x 67	89	1102	1509	4800	4140		3x1400
090.234-...	2 x 67	118	1470	1642				
090.242-...	2 x 67	76	980	1831				
090.243-...	2 x 80	114	1470	2007	6200	5540	2740	4x1400
090.244-...	2 x 80	152	1960	2182				
090.252-...	2 x 67	93	1225	2286				
090.253-...	2 x 80	139	1837	2504	7600	6940	4140	5x1400
090.254-...	2 x 80	186	2450	2722				

## Technical Data HTC ... . 2••

Type	Refrigerant conn. mm	Int. vol. dm <sup>3</sup>	Sur-face m <sup>2</sup>	Weight kg	Dimensions mm			
					A	B	C	D
<b>HTC 091 n = 850 / 610 rpm</b>								
091.212-...	2 x 35	25	304	502				
091.213-...	2 x 42	38	457	557	2350	1690		1x1750
091.214-...	2 x 42	50	607	613				
091.222-...	2 x 54	51	607	1004				
091.223-...	2 x 54	76	913	1115	4100	3440		2x1750
091.224-...	2 x 54	101	1214	1227				
091.232-...	2 x 67	72	911	1500				
091.233-...	2 x 67	108	1370	1665	5850	5190		3x1750
091.234-...	2 x 80	144	1822	1830				
091.242-...	2 x 67	93	1214	1996				
091.243-...	2 x 80	139	1827	2214	7600	6940	3440	4x1750
091.244-...	2 x 80	186	2429	2432				
091.252-...	2 x 80	114	1518	2493				
091.253-...	2 x 80	171	2284	2764	9350	8690	5190	5x1750
091.254-...	2 x 80	228	3036	3035				
<b>HTC 100 n = 670 / 520 rpm</b>								
100.212-...	2 x 35	25	304	502				
100.213-...	2 x 35	38	457	557	2350	1690		1x1750
100.214-...	2 x 42	50	607	613				
100.222-...	2 x 42	51	607	1004				
100.223-...	2 x 54	76	913	1115	4100	3440		2x1750
100.224-...	2 x 54	101	1214	1227				
100.232-...	2 x 54	72	911	1500				
100.233-...	2 x 67	108	1370	1665	5850	5190		3x1750
100.234-...	2 x 67	144	1822	1830				
100.242-...	2 x 67	93	1214	1996				
100.243-...	2 x 67	139	1827	2214	7600	6940	3440	4x1750
100.244-...	2 x 80	186	2429	2432				
100.252-...	2 x 67	114	1518	2493				
100.253-...	2 x 80	171	2284	2764	9350	8690	5190	5x1750
100.254-...	2 x 80	228	3036	3035				
<b>HTC 100 n = 420 / 310 rpm</b>								
100.212-...	2 x 35	25	304	502				
100.213-...	2 x 35	38	457	557	2350	1690		1x1750
100.214-...	2 x 35	50	607	613				
100.222-...	2 x 42	51	607	1004				
100.223-...	2 x 54	76	913	1115	4100	3440		2x1750
100.224-...	2 x 54	101	1214	1227				
100.232-...	2 x 54	72	911	1500				
100.233-...	2 x 54	108	1370	1665	5850	5190		3x1750
100.234-...	2 x 54	144	1822	1830				
100.242-...	2 x 54	93	1214	1996				
100.243-...	2 x 67	139	1827	2214	7600	6940	3440	4x1750
100.244-...	2 x 67	186	2429	2432				
100.252-...	2 x 67	114	1518	2493				
100.253-...	2 x 67	171	2284	2764	9350	8690	5190	5x1750
100.254-...	2 x 80	228	3036	3035				

# Air Cooled Condensers

# HTC

HTC 076 / 090 / 091 / 100 . 2••  
Vertical Air Direction

Side View

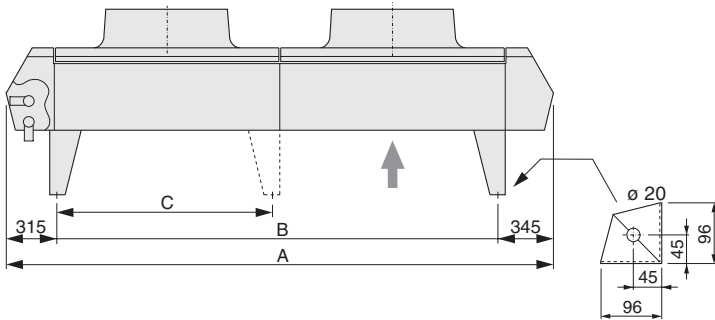

HTC 076 . 2••

HTC 090 / 091 . 2••

HTC 100 . 2••

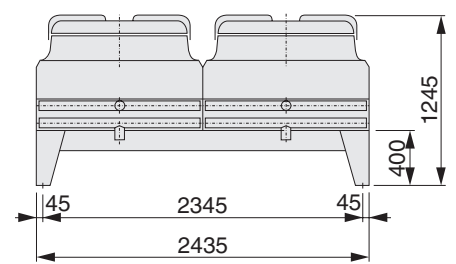
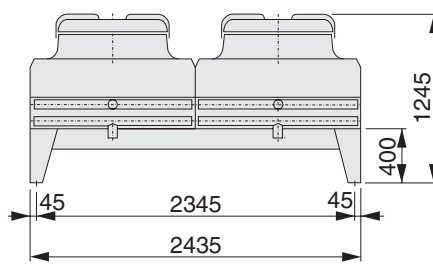
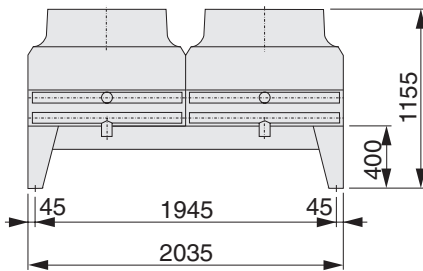

HTC 076 / 090 / 091 / 100 . 2••  
Horizontal Air Direction

HTC 076.2••

HTC 090/091. 2••

HTC 100. 2••

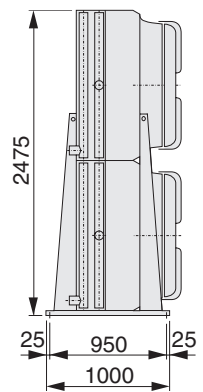
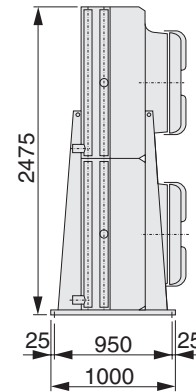
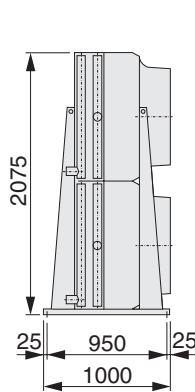
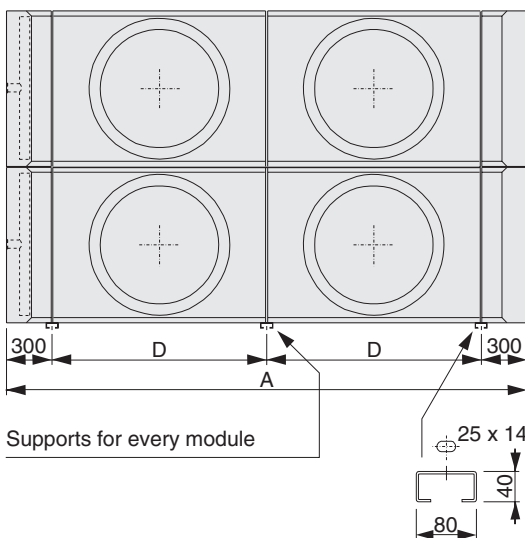

# Air Cooled Condensers

# HTC

## Fan types

All fan types have corrosion resistant fan blades and fan guards.

### HTC Type 050

Fans ø 508 mm, complete with protection guards and anti vibration mountings.  
Standard execution with fan motors type 050.910.  
Terminal boxes are provided with 2 cable inlets M20 x 1.5.

### HTC Type 076

Fans ø 762 mm mounted on a motor support.  
Fan guards are integrated in the fan plate.  
Standard execution with fan motors type 076.930.  
Motors are wired to one or more common terminal boxes. The terminal boxes are located on the endplate at the liquid header end of the coil.

### HTC Type 090 / 091

Fans ø 900 mm, fan motors integrated with guards and mounted to fan discharge hood.

### HTC Type 100

Similar in construction to type 090 / 091, fan diameter however 1000 mm.

All fan motors of HTC models **090**, **091** and **100** are equipped with an overload protector built in the windings. Via terminals in the terminal box this internal protector **must** be used in the control current circuit. The electrical control should be arranged in such a way that continuous on/off switching of the motors ('tripping') is prevented.  
When the condensers are out of use for longer periods, the motors have to be switched on for at least 2 hours every month.

### HTC Type 050 - 100

For application at ambient temperatures above 40 °C : special motors on request.

## Fan motors

Motor type	Number of poles	rpm	Capacity		Motor voltage Volt	Thermal overload relay settings (A) * 230 / 400
			nominal Watt	absorbed Watt		

### HTC type 050 (enclosed design, IP-55)

050 . 910	6	910	180	350	230/400/50/3	1.49 / 0.86
050 . 690	8	690	120	250	230/400/50/3	1.16 / 0.67
050 . 470	12	470	25	100	230/400/50/3	0.55 / 0.32
050 . 1420	4	1420	370	600	230/400/50/3	2.42 / 1.40
050 . VAR	6	var.	180	350	230/50/1	2.36 **

### HTC type 076 (enclosed design, IP-55)

076 . 930	6	930	750	1170	230/400/50/3	5.0 / 2.9	
076 . 690	8	690	370	560	230/400/50/3	2.6 / 1.5	
076 . 325	16	325	120	290	230/400/50/3	2.0 / 1.2	
076 . 425	YI	6	935	750	1420	400/50/3	3.1
	YII	12	425	150	300	400/50/3	1.1
076 . 930	M	6	930	750	1170	230/50/1	8.0
076 . VAR		6	var.	750	1000	230/50/1	8.4 **
076 . 840		8	840	660	770	230-254/400-440/60/3	4.8 / 2.8

### HTC type 090 (enclosed design, IP-54)

090 . 850	Δ	-	850	3300	400/50/3	6.93
	Y	-	610	1900	400/50/3	3.85
090 . 680	Δ	-	680	1750	400/50/3	3.96
	Y	-	520	1200	400/50/3	2.53
090 . 860	Δ	-	830	1600	400/50/3	3.85
	Y	-	610	910	400/50/3	1.98

### HTC type 091 (enclosed design, IP-54)

091 . 850	Δ	-	850	3300	400/50/3	6.93
	Y	-	610	1900	400/50/3	3.85
091 . 680	Δ	-	680	1750	400/50/3	3.96
	Y	-	520	1200	400/50/3	2.53
091 . 860	Δ	-	830	1600	400/50/3	3.85
	Y	-	610	910	400/50/3	1.98

### HTC type 100 (enclosed design, IP-54)

100 . 670	Δ	-	650	2200	400/50/3	4.6
	Y	-	460	1350	400/50/3	3.0
100 . 420	Δ	-	420	860	400/50/3	2.2
	Y	-	310	500	400/50/3	1.07
100 . 380	Δ	-	380	670	400/50/3	1.54
	Y	-	250	330	400/50/3	0.74

\* The settings can be applied to a minimum ambient temperature of -10 °C

\*\* Value at highest speed.

Note : Actual fan speed may differ from the values as indicated on the motor name plate.

# Air Cooled Condensers

# HTC

## Factors for calculation of the condenser capacity

The condenser capacity is the compressor capacity multiplied with the factor from the diagram. The diagrams are valid for R 404A. At evaporating temperatures below -20 °C the condenser capacity has to be calculated from the compressor capacity at -20 °C, or a starting control should be used to protect the compressors from high starting loads.

OPEN compressors

SEMI-HERMETIC compressors  
(motor air/water cooled)

Factor

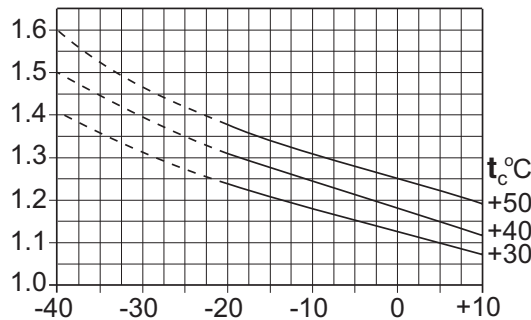

Evaporating temperature °C

SEMI-HERMETIC compressors  
(motor suctiongas cooled)

HERMETIC compressors

Factor

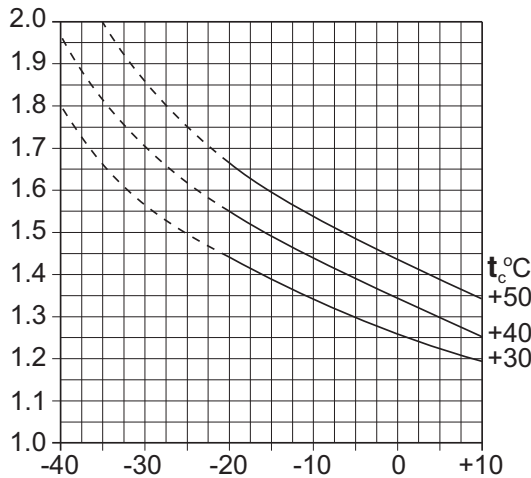

Evaporating temperature °C

## Capacity

The basic capacity ratings (pages 4, 5 and 8, 9) are for R404A at a  $t_d$  \* of 15 K and ambient temperatures up to 25 °C.

\*  $t_d$  = difference between condensing- and ambient temperature.

Capacities are directly proportional with other temperature differences between 10 and 20 K.

The refrigerant circuiting is optimised to the selected fan speed. When selecting a condenser model with two fan speeds a 'first choice' fan speed has to be given to which the refrigerant circuiting will be designed. The condenser capacity for the 'second choice' fan speed can be up to 10 % below the stated capacity.

## Correction factors

		Factor
Refrigerant	R 404A, R 507	1.00
	R 134a	0.93
	R 407C	0.87
	R 22	0.96
Ambient temperature :	25 °C	1.00
	35 °C	0.96
	40 °C	0.94
	50 °C (special motor)	0.91
Altitude above sea level :	0 m	1.00
	500 m	0.97
	1000 m	0.93
	1500 m	0.90
	2000 m	0.86
	2500 m	0.83
Application of motors suitable for 60 Hz with n = 840 rpm		0.95

### Example : HTC 076 . 124 - 60 Hz fans

What is the condenser capacity at an ambient temperature of 40 °C, refrigerant R404A, altitude at sea level and equipped with motors for 60 Hz ?

Nominal capacity at 15 K tv : 110.7 kW  
 Correction factors :  $t = 40$  °C : 0.94  
 altitude sea level : 1.00  
 60 Hz motors : 0.95

Corrected capacity :  
 $0.94 \times 1.00 \times 0.95 \times 110.7 = 98.9$  kW

## Capacity control

For multifan models capacity can be controlled by cycling one or more fans. Capacity control on all models is also possible by using 2-speed or speed regulated single phase motors (in combination with an electronic speed control device).

The fan compartments are separated by baffle plates.